

- Ⓓ Anschluss **ausschließlich** durch ausgebildete Elektro-Fachkräfte.
- Ⓔ Electrical connection is to be made by trained electrical specialists **only**.
- Ⓕ Le branchement doit **uniquement** être effectué par des professionnels.
- Ⓘ Il collegamento deve essere eseguito **solo** da elettricisti specializzati.
- Ⓔ La conexión **sólo** debe ser realizada por electricistas debidamente formados.
- Ⓕ A ligação deve ser feita **exclusivamente** por profissional eléctrico especializado.
- Ⓒ Připojení smí **provádět** pouze kvalifikovaný personál.
- Ⓔ Podłączenie **wyłącznie** przez specjalistów-elektryków.
- Ⓕ Liittäminen kuuluu **ainoastaan** koulutettujen sähköalan ammattilaisten tehtäviin.
- Ⓔ Подключение проводится только специалистом-электриком.
- Ⓕ Bağlantı **sadece** eğitimli elektrik teknisyenleri tarafından yapılmalıdır.
- Ⓒ 布线需由专业电工执行

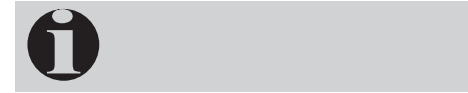

	90 dB (10 cm), f = 2400 Hz (12 V : f = 3200 Hz)
118 483 15	24 V \approx (12-30 V), 20 mA, 2400 Hz
118 483 28	230 V \sim (110-240 V), 20 mA, 2400 Hz
	90 dB (10 cm) f = 2400 Hz / 1Hz (12 V : f = 3200 Hz / 1 Hz)
119 483 15	24 V \approx (12-30 V), 20 mA, 2400 Hz
119 483 28	230 V \sim (110-240 V), 20 mA, 2400 Hz

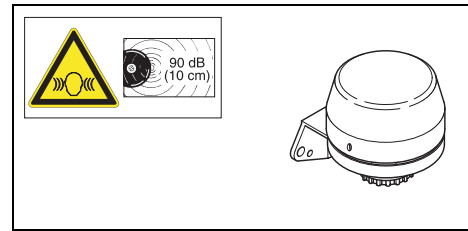
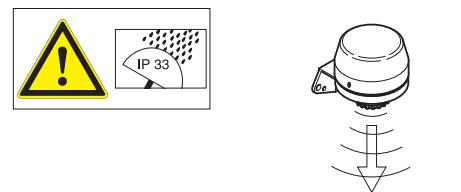
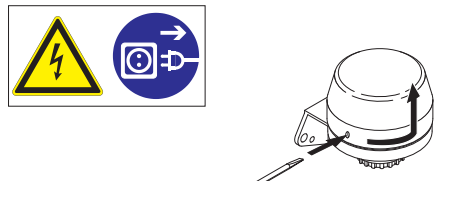

1

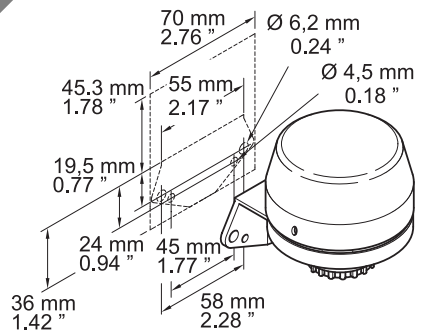

2

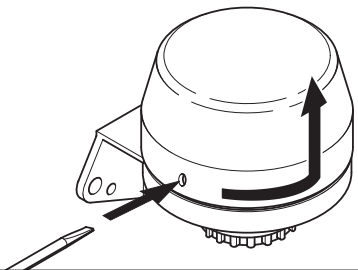

3

3a - 118 483 15, 118 483 28
3b - 119 483 15, 119 483 28

3a

\varnothing 5 - 8 mm
0.2" - 0.32"

\leq 25 mm
1.00"

17 mm 0.28"
 \leq 1,5 mm²
AWG 18-14

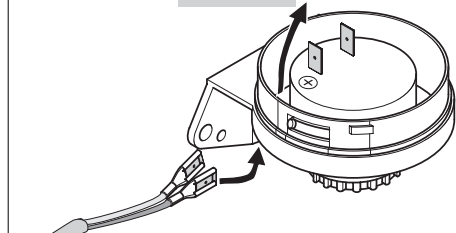

3b

\varnothing 5 - 8 mm
0.2" - 0.32"

\leq 25 mm
1.00"

17 mm 0.28"
 \leq 1,5 mm²
AWG 18-14

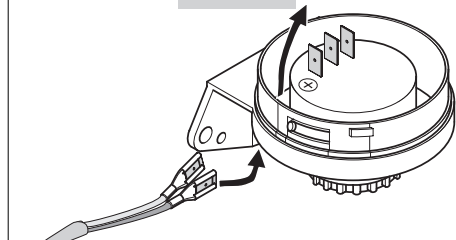

4

4a - 118 483 15, 118 483 28
4b - 119 483 15, 119 483 28

4a

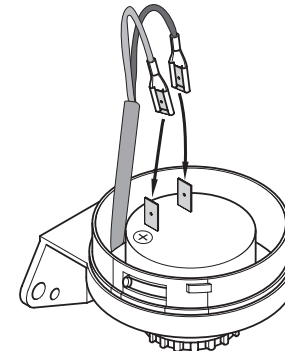
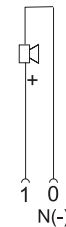

4b

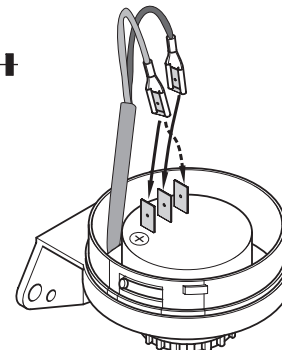
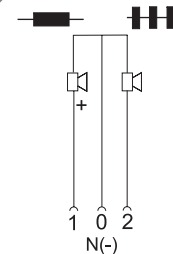

5

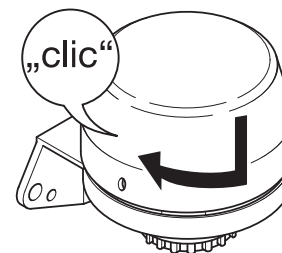

310.118.001.0308

© D

WERMA
SIGNALTECHNIK